

Hunter Valley Closedown Briefing Document

To be read in conjunction with TAA 0003-2025, and the following ARTC Network Rules and Procedures:

- **ANWT-302:** Local Possession Authority.
- **ANPR-700:** Using a Local Possession Authority.
- **ANWT-314:** Work Trains.
- **ANWT-316:** Track Vehicles.
- **ANPR-710:** Piloting Trains and Track Vehicles.
- **ANWT-300:** Planning Work in the Rail Corridor.
- **ANWT-310:** Lookout Working.
- **ANPR-711:** Lookouts.
- **ANGE-216:** Level Crossings.
- **ANPR-715:** Protecting Type F Level Crossing.
- **ANPR-716:** On Site Testing of Type F Level Crossing.
- **ANPR-717:** Using Emergency Roadside Warning Equipment.
- **ANWT-312:** Infrastructure Booking Advice.
- **ANPR-704:** Using Infrastructure Booking Advices.
- **ANGE-204:** Network communication.
- **ANPR-721:** Spoken and Written Communication.

Note: The closedown specific documents can be found at the following website:

Possessions Web page - <https://www.artc.com.au/work/hunter-valley-possession-management/>

The purpose of the briefing documents is to outline the plan for the February Major South Closedown, and includes possession details, scope of works, contact details, track vehicle and work train movements and schematic track diagrams.

CLOSEDOWN TIMELINE

The timeline for Closedown start-up from start time on the TAA is as follows:

START UP

Protection Officers seeking permission to start shall contact the PPO after.

0800 hours Tue 18th/Feb	Protection Officers ring on with the PPO
2100 hours Tue 18th/Feb	Islington to Maitland Mains Possession
2100 hours Wed 19th/Feb	Islington to Maitland Mains Possession

HANDBACK

Certification of all work and worksite protection removed before.

0230 hours Wed 19th/Feb	Hanback Islington to Maitland Mains Possession
0230 hours Thu 20th/Feb	Hanback Islington to Maitland Mains Possession
0500 hours Fri 21st/Feb	All Stages Certified and off track.

CLOSEDOWN CONTACTS

PPO: (02) 4979 7020

CD COORDINATOR: (02) 4979 7021

PPO Track Machine: (02) 4979 7033

0500 – 0900 Each Morning for all worksites working between **ALLANDALE** (204.000 KM) to **GRASSTREE** (283.015 KM)

PPO & PPO Track Machine Contact: (02) 4979 7016

(All of the above phone lines are recorded)

PHONE PROTOCOL

The following phone Protocol will be adhered to:

1. Identify your Job Number and description.
2. Identify yourself by name.
3. Identify your current location, affected track/s and protection kilometrage.

CLOSEDOWN PROTOCOL

1. Incidents / Emergencies.

In the event of an incident or near miss the following steps should be followed:

1. Make sure the worksite is safe and immediately arrange for treatment of any injuries.
2. Contact Network Control only if it is an emergency, i.e. you need to stop trains on a running line, or emergency services need to access the site.
3. Inform your ARTC Job Owner or Representative.
4. Inform the Closedown Co-ordinator, **only if the incident / emergency will impact access to the corridor, the condition of the network or the closedown handback.**

2. Access Gates.

All access gates are to be closed and locked at all times unless attended during the time access is required.

3. Infrastructure Booking Advice (IBA)

- Any IBAs taken out during the Closedown that will not be fulfilled prior to hand back are to be notified to the Closedown Co-ordinator by the IBA holder.
- Maintenance Representatives **MUST** ensure the PPO is advised when Level Crossing Warning Equipment or Points are booked out of use and the conditions/restrictions on the use of the equipment. (e.g. condition of Points, can they be manually operated? Can you transfer?)
- Maintenance Representatives are requested to place their Job Number within the IBA number and their phone number on the form.

Where practical IBAs are to be emailed to the NCCNIBA@artc.com.au the day prior to the Closedown, the IBA must contain the Network Control Board for the IBA in the Subject field.

4. Level Crossings.

Before booking out level crossing warning equipment the Competent Worker must check with the PPO to ensure no rail traffic is approaching the level crossing and advise the PPO of the name and contact number of the Handsignaller at the level crossing.

Note: the IBA for booked out level crossings cannot be fulfilled with any alarms associated with the Level Crossing activated.

5. Rail Traffic within LPA limits.

Traffic Officers, and Pilots are advised that the following **MUST** be observed.

- Rail Traffic **MUST** travel at restricted speed (up to a maximum of 40km/hour). Restricted speed is a speed that allows rail traffic to stop short of an obstruction within the distance of clear line that is visible ahead.
- The Qualified responsible person for the Rail Traffic **MUST** be the single point of contact with the PPO.

6. Certification.

It is the responsibility of the Job Owner to ensure that a competent and qualified person has been nominated to certify the Job. On completion of the work the nominated person(s) must contact the Closedown Coordinator and certify that the infrastructure is fit for purpose. A verbal certification is sufficient. When contacting the Closedown Coordinator, the certifier shall identify their job number, name, confirm the scope and certify that the infrastructure is fit for purpose.

The project manager needs to ensure that each section of the certification has been addressed. The 3 sections of certification are as follows:

Civil: Track, track formation and drainage, and fixed structures beside over or under the track. This includes supports for signalling, electrical and telecommunications equipment. (Track Geometry is excluded from civil certification only if Tamping certification has been nominated).

Signal: All signalling and telecommunication equipment.

Tamping: Track Geometry (only).

Any Temporary Speed Restrictions (TSR) or conditions affecting the network placed on the track due to work in the Closedown need to be identified to the Closedown Coordinator as part of the certification.

Communication Flow Chart

Worksite with a Coordinating Protection Officer

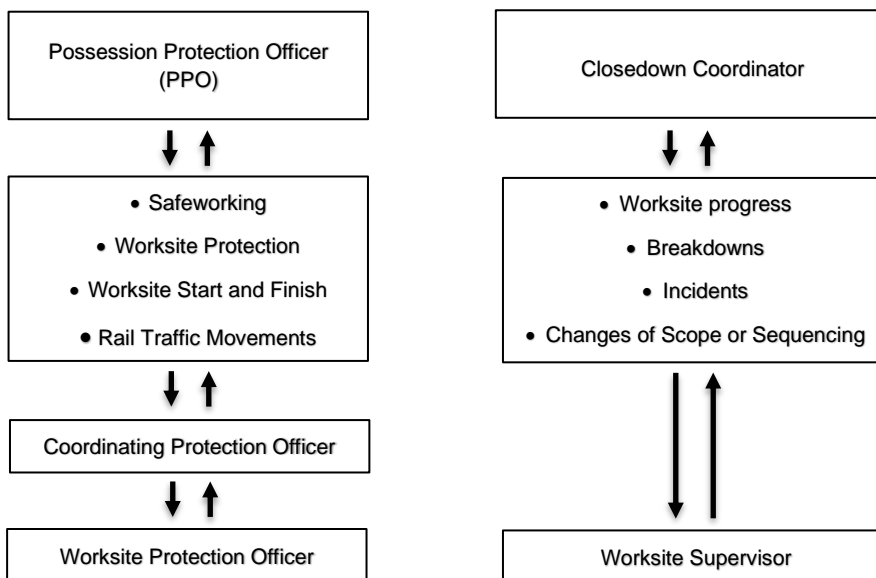

Worksite with NO Coordinating Protection Officer

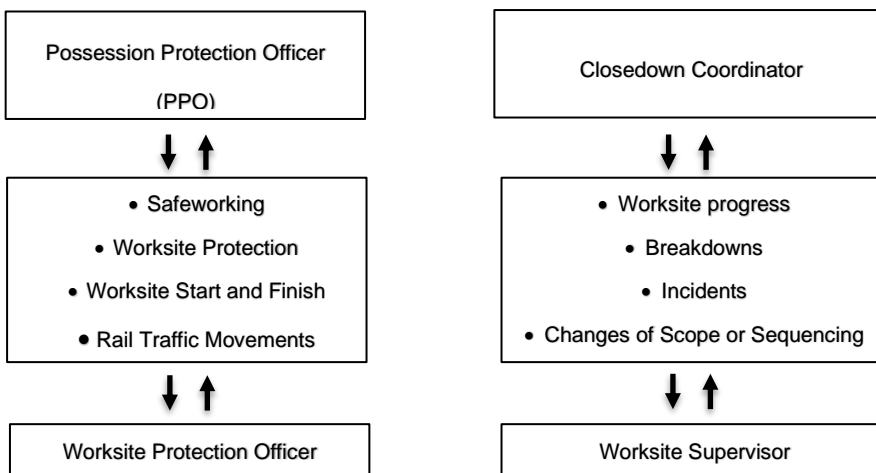

WORKSITE SUPERVISORS

The Closedown Coordinator and the supervisors shall liaise to ensure the efficient delivery of the planned scopes of work. Supervisors or site representatives must report any changes to scope/sequencing to the Closedown Coordinator prior to enacting the change.

PROTECTING WORKSITES

To be Coordinated as separate workings the following procedure applies.

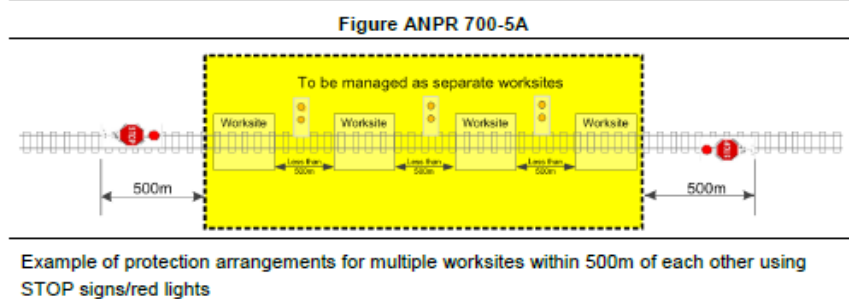
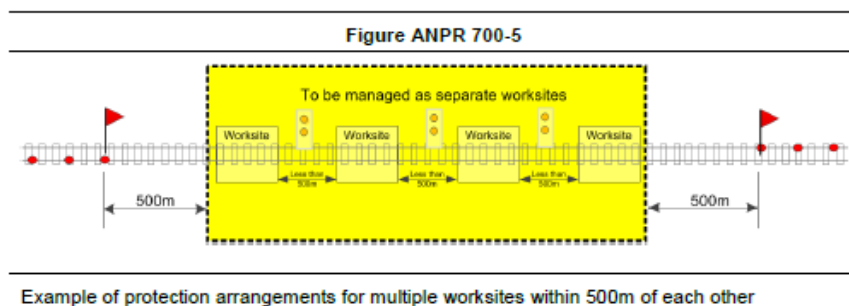

Responsibilities

Where Delineation Markers are in use, the *Coordinating Protection Officer* will be responsible for:

- briefing all Worksite Protection Officers entering the Coordinated Worksite of the Coordinated Worksite protection arrangements, and
- managing all rail traffic movements entering, working in and exiting the Coordinated Worksite limits, and
- notifying the Worksite Protection Officers within the Coordinated Worksite that will be affected by any rail traffic movement of the intended rail traffic movements before allowing any movements, and
- notifying the Pilots or Track Vehicle Operators of the rail traffic of the location of each work group working within the Coordinated Worksite, including the location of delineation markers to define worksite limits, and
- notifying the Possession Protection Officer of all work groups who have arrived and departed the Coordinated Worksite, and
- notifying the Possession Protection Officer of changes of the Coordinated Worksite protection arrangements.

The *Worksite Protection Officer* will be responsible for:

- briefing the workers of the Coordinated Worksite protection arrangements, and
- coordinating all rail traffic movements within their worksite limits, and
- for the protection of workers from rail traffic within their individual worksite limits, and
- for the protection of workers from rail traffic on adjacent live lines

Note: The Coordinating Protection Officer must be the single point of contact with the Possession Protection Officer.

To be Coordinated as one worksite the following procedure applies.

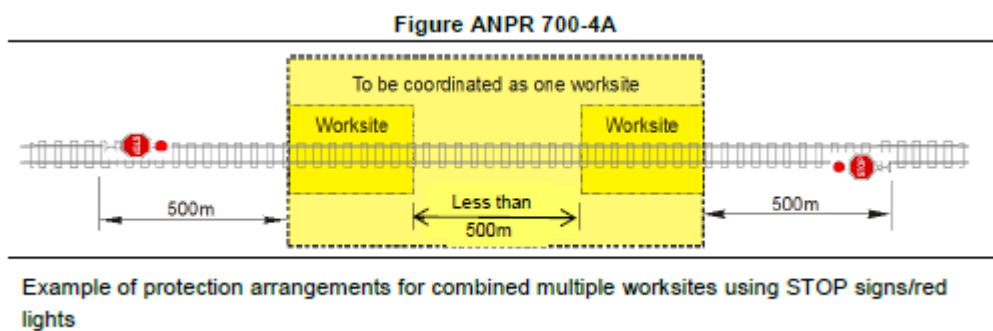
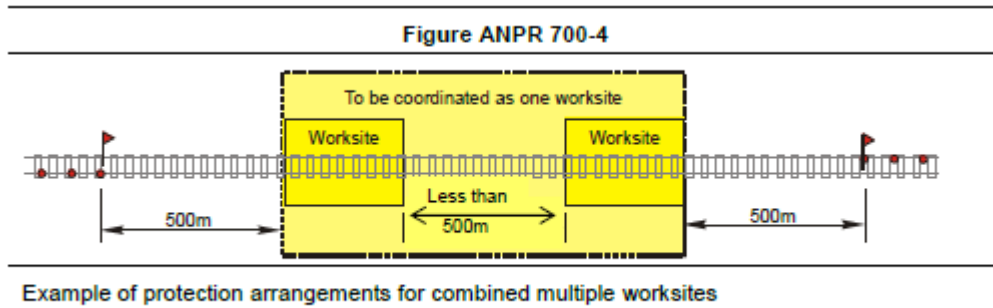

Responsibilities

Where Delineation Markers are NOT in use, the *Coordinating Protection Officer* will be responsible for:

- managing all safeworking within the worksite;
- briefing the Worksite Protection Officers of the Coordinated Worksite protection arrangements, and;
- notifying the Possession Protection Officer of all worksites arriving and departed the worksite;
- notifying the Possession Protection Officer of Work site protection changes.

Note: The Coordinating Protection Officer must be the single point of contact with the Possession Protection Officer.

Fulfilling a worksite

Once a worksite has been established it remains a worksite until all of the following have been completed:

- All workers and plant are clear of the worksite, and
- All protection has been removed, and
- The track has been certified fit for service, and
- Any Temporary Speed Restrictions (TSR) or conditions affecting the network placed on the track due to work in the Closedown need to be identified to the PPO.

If any one of these items has not been completed it is still deemed a worksite and as such must be protected as a worksite per ANPR700.

Note: track machines stabled within the LPA must be protected as worksites.

If worksite protection is to be left on track the protection officer must hand the worksite over to another protection officer before removing their tags and leaving the worksite.

Handing over Worksite Protection.

At the completion of shift, where worksites or Obstruction/Track Vehicles remain within the limits of the combine multiple worksite the Coordinating PO MUST:

- Contact all remaining worksites and inform of the intention of leaving site,
- If there is no relieving Coordinating PO to take over the Coordinated Worksite, the remaining worksites protection Officers must confer and nominate a single PO responsible for managing the Coordinated Worksite.
 - Communicating any and all conditions or restrictions of tracks within the site
 - Any IBA's relating to points or level crossings are identified and the use or restrictions on the use of the equipment
- Once a new Coordinating PO has been selected and if the worksite protection arrangements change, the PPO must be notified of the new arrangements.
- The new Coordinating PO must ensure Worksite Protection Name Tags are attached to the Coordinated Worksite protection equipment.

If there is no Protection Officer, the worksite can be handed over to the PPO the following conditions apply.

- No personnel are within the limits of the worksite,
- All obstructions are protected (I.e., Track Machines stabled on track, track not fit for purpose)
 - Communicating any and all conditions or restrictions of tracks within the site
 - Any IBA's relating to points or level crossings are identified and the use or restrictions on the use of the equipment

Lookout Working within an LPA

Lookout Working must be used in compliance with **ANWT-310** and **ANPR-711**

- Lookout Working Must be taken through Network Control and PPO
- The gazetted track speed must be used to calculate the Lookout Warning times as per **ANPR-711**

Where Lookout Working is to be used within the limits of a Local Possession Authority (LPA) the Protection Officer (PO) must also contact the Possession Protection Officer about:

- commencing Lookout Working, and
- ending Lookout Working.

The Possession Protection Officer must:

- advise the Lookout Working PO of the worksites within the Lookout Working limits, and
- any current rail traffic movements within the lookout Working limits.

The Protection Officer must:

- advise the PPO of the worksite limits and tracks for Lookout Working, and
- contact the Protection Officer of fixed worksites before entering the worksite / protection limits as identified below '*Entering an existing worksite*'.

New Worksites Entering the LPA:

Where a new workgroup is to establish a worksite in a section where Lookout Working is in place

- The PPO must advise the PO of the workgroup of the Lookout Working workgroup contact details and the Lookout Working limits,
- The new workgroup PO must contact the PO for the Lookout Working workgroup and make agreed arrangements for the works to be completed,
- If the Lookout Working workgroup is within the limits of the new worksite, the worksite PO must advise the PPO that the Lookout Working workgroup is located within the worksite limits.

Entering an existing worksite:

Prior to entering an existing worksite in the corridor, the PO for the Lookout Working Workgroup must:

- Contact the PO for the worksite and,
- Gain authority from the PO to enter the pre-existing worksite and,
- Get briefed into the worksite by the PO, and
- Inform the PPO that the Lookout Working Workgroup has entered an existing worksite location

Exiting an existing worksite:

When exiting an existing worksite location, the PO for the Lookout Working must:

- Gain Authority from the PPO to exit the worksite and commence / continue Lookout Working in the LPA limits, and
- Inform the Worksite PO that the Lookout Working Workgroup has left the limits of the worksite

WORKSITE PROTECTION IDENTIFICATION INSTRUCTION

This instruction is applicable to all worksites within Hunter Valley Closures.

- **When worksite protection is placed, the Protection Officer responsible for the worksite protection must ensure that an identification tag displaying their name and phone number is securely attached to:**
 - each red flag or red light.
 - each point clip or associated SL lock.
- In cases where a worksite or other hazard is to be left unattended with protection in place, the PO responsible for the protection must ensure the PPO is advised of the circumstances before removing their name tag.
- When a worksite PO is being relieved, the incoming PO must check that identification tags are secured to the worksite protection and that the correct details are displayed on each tag.
- If worksite protection is found with identification tags missing, or shows the incorrect information, the PPO is to be advised immediately.
- In cases where worksites are protected at the midpoint between worksites, both worksite POs must attach their own identification tags to the associated worksite protection.
- Worksite Protection Tags are required on LPA Protection or Delineation.
- LPA protection will have the PPO's contact details on them attached.

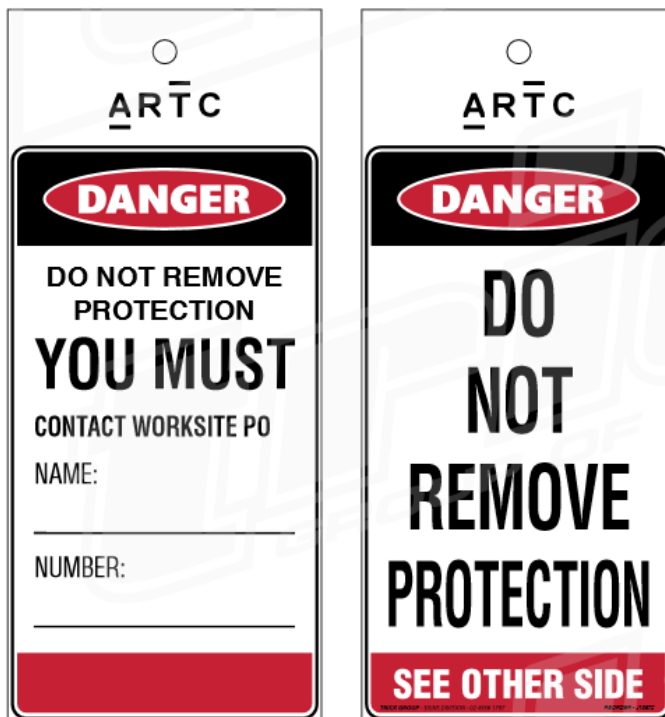

Figure One: Sample Tag

Trains Stabled in Loops

Note trains may be stabled at the following locations:

- Hexham Holding Road 2-4
- Kooragang Arrival Road 1-3

Safe Notices

SAFE NOTICES FOR THIS CLOSEDOWN:

- **SN 2-5673** Altered Safeworking Arrangements for Hunter Valley Closedown (SOUTH)
- **SN 2-5674** Greta Altered Possession Protection Arrangements
- **SN 2-5675** Hexham Altered Possession Protection Arrangements
- **SN 2-5676** ARTC/PWCS Interface Boundary Arrival Road Kooragang
- **SN 2-5677** South Maitland Railway Altered Possession Protection Arrangements
- **SN 2-5678** Kooragang NCIG Altered Possession Arrangements

Other Safe Notices may have been issued since this document was printed. Job owners must ensure any relevant Safe Notices are available on site.